

Materials	Temp. Range	
Nitrile (NBR)	-40°C	to 120°C
Low Temp. Nitrile (LTN)	-54°C	to 116°C
Hydrogenated Nitrile (HNBR)	-40°C	to 160°C
Viton™/Fluorocarbon (FKM)	-26°C	to 204°C
Polytetrafluoroethylene (PTFE)	-260°C	to 260°C
Aflas® (FEPM)	-9°C	to 232°C
Chloroprene (CR)	-40°C	to 121°C
Ethylene Propylene (EPDM)	-54°C	to 150°C
Perfluoroelastomer (FFKM)	-32°C	to 350°C
Silicone (VMQ)	-65°C	to 232°C
Fluorosilicone (FVMQ)	-56°C	to 204°C

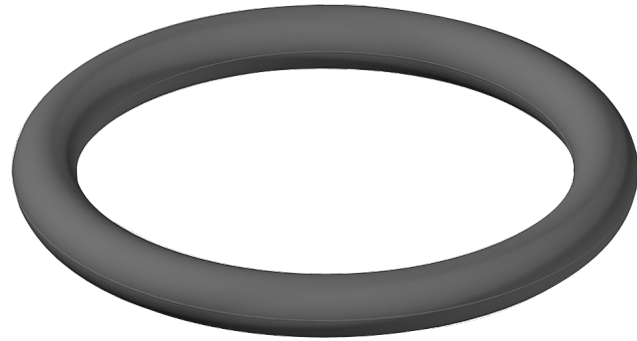

Product Description

O-rings are designed for both static and dynamic applications. A properly designed O-ring groove allows the O-ring to be squeezed diametrically out-of-round even before the application of pressure. The O-ring seals by distortion of its resilient elastic compound to fill the leakage path. Metric O-rings are available in standards DIN 3771, BS4518, ISO 3601, European sizes, and JIS sizes. We also offer O-rings meeting different standards and custom sizes.

Part Numbers:

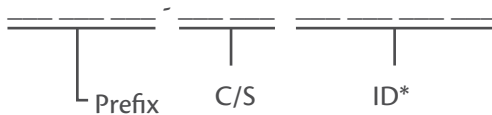

The fourth ID digit is added to the part number when the ID contains a decimal place.

O-Rings

MN7 - NBR	ME7 - EPDM	MTO - PTFE
MN8 - NBR	MH7 - HNBR	MU8 - PU
MN9 - NBR	MH8 - HNBR	MU9 - PU
MV7 - Viton™ FKM	MH9 - HNBR	MK7 - Kalrez® FFKM
MV8 - Viton™ FKM	MS7 - VMQ	MK9 - Kalrez® FFKM
MV9 - Viton™ FKM	MA7 - Aflas® FEPM	

Example: MN7 400145 - Nitrile, 70 Durometer - 4.00 mm C/S, 14.50 mm ID

Example: MH8 45105 - Hydrogenated Nitrile, 80 Durometer - 4.50 mm C/S, 105.00 mm ID

O-Ring Tolerances

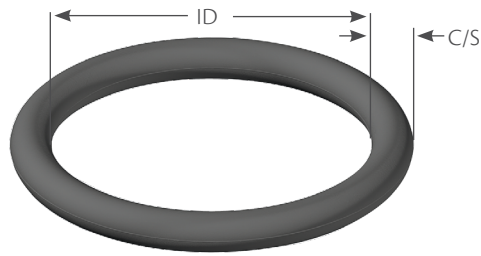

Information based on ISO 3601 Non-Standard Class A O-Rings.

Cross Section (C/S)	Tolerance mm
0.80 < C/S ≤ 3.15	± 0.08
3.15 < C/S ≤ 4.50	± 0.10
4.50 < C/S ≤ 6.30	± 0.13
6.30 < C/S ≤ 8.40	± 0.15
*9.00 ≤ C/S ≤ 20.00	± 0.20

*Based on DIN 3771.

Machining information and tolerances for various standards are available through us.

Information provided in this catalogue is meant to aid with seal selection process. Contact us for assistance in designing an application.

Inside Diameter (ID) mm		Tolerance mm
0.68	to 1.53	± 0.10
1.54	to 11.69	± 0.13
11.70	to 13.46	± 0.15
13.47	to 17.53	± 0.18
17.54	to 20.57	± 0.20
20.58	to 23.88	± 0.23
23.89	to 28.70	± 0.25
28.71	to 35.56	± 0.30
35.57	to 43.18	± 0.36
43.19	to 50.80	± 0.41
50.81	to 58.42	± 0.46
58.43	to 66.55	± 0.51
66.56	to 74.93	± 0.56
74.94	to 83.57	± 0.61
83.58	to 92.20	± 0.66
92.21	to 101.60	± 0.71
101.61	to 117.35	± 0.76
117.36	to 141.22	± 0.89
141.23	to 166.37	± 1.02
166.38	to 192.02	± 1.14
192.03	to 218.69	± 1.27
218.70	to 253.37	± 1.40
253.38	to 289.56	± 1.52
289.57	to 347.98	± 1.78
347.99	to 408.94	± 2.03
408.95	to 472.44	± 2.29
472.45	to 571.50	± 2.54
571.51	to 711.20	± 3.05
711.21	to 855.98	± 3.56
855.99	to 1005.84	± 4.06
1005.85	to 1163.32	± 4.57
1163.33	to 1320.80	± 5.08

Static Radial Applications

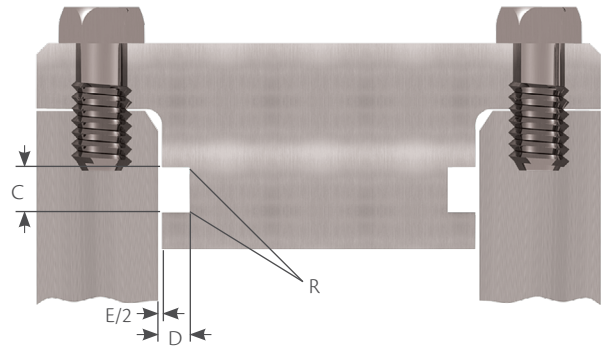

Information is based on DIN. 3771.

O-ring C/S	±	D Gland Depth	±	E Diametrical Clearance	C Groove Width +0.13/-0.00	R Groove Radius	Max. Eccentricity
1.00	0.08	0.72	0.02	0.10	1.35	0.2	0.05
1.20	0.08	0.87	0.02	0.10	1.60	0.2	0.05
1.50	0.08	1.09	0.02	0.10	2.00	0.2	0.05
1.60	0.08	1.16	0.03	0.10	2.10	0.2	0.05
1.78 - 1.80	0.08	1.29	0.03	0.10	2.35	0.2	0.05
1.90	0.08	1.38	0.03	0.10	2.50	0.2	0.05
2.00	0.08	1.45	0.04	0.10	2.65	0.2	0.05
2.40	0.08	1.90	0.04	0.10	3.25	0.2	0.05
2.50	0.08	1.98	0.04	0.10	3.40	0.2	0.05
2.62	0.08	2.07	0.04	0.10	3.55	0.2	0.05
3.00	0.08	2.40	0.04	0.15	4.05	0.5	0.07
3.50 - 3.53	0.10	2.82	0.05	0.15	4.75	0.5	0.07
3.60	0.10	2.88	0.05	0.15	4.85	0.5	0.07
4.00	0.10	3.20	0.06	0.15	5.40	0.5	0.07
4.50	0.10	3.64	0.06	0.15	6.00	0.5	0.07
5.00	0.13	4.04	0.06	0.15	6.70	0.7	0.10
5.33- 5.34	0.13	4.31	0.08	0.15	7.15	0.7	0.10
5.50	0.13	4.45	0.08	0.15	7.35	0.7	0.10
5.70	0.13	4.61	0.08	0.15	7.65	0.7	0.10
6.00	0.13	4.91	0.08	0.18	8.15	0.7	0.13
6.99	0.15	5.72	0.10	0.18	9.50	0.7	0.13
7.00	0.15	5.73	0.10	0.18	9.55	0.7	0.13
7.50	0.15	6.14	0.10	0.18	10.20	1.0	0.13
8.00	0.18	6.55	0.10	0.18	10.90	1.0	0.13
8.40	0.18	6.87	0.15	0.18	11.45	1.0	0.13
9.00	0.2	7.65	0.15	0.18	11.85	1.0	0.13
10.0	0.2	8.50	0.15	0.18	13.20	1.0	0.13
11.0	0.2	9.35	0.15	0.18	14.50	1.0	0.13
12.0	0.2	10.20	0.15	0.18	15.85	1.5	0.13
13.0	0.2	11.05	0.15	0.18	17.15	1.5	0.13
14.0	0.2	11.90	0.3	0.18	18.45	1.5	0.13
16.0	0.2	13.60	0.3	0.18	21.10	1.5	0.13
18.0	0.2	15.30	0.3	0.18	23.75	1.5	0.13
20.0	0.2	17.00	0.3	0.18	26.40	1.5	0.13

Static Axial (Face) Applications

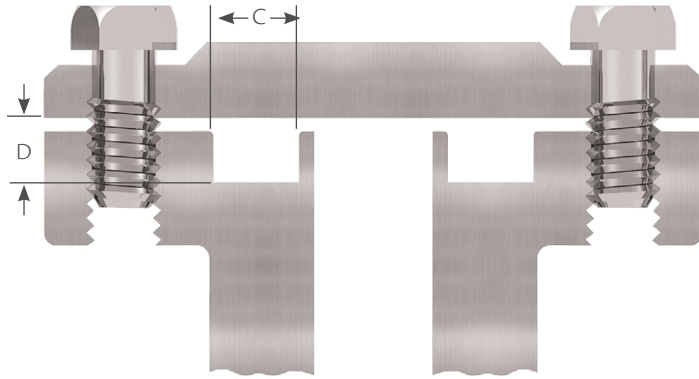

Information is based on DIN. 3771.

O-Ring C/S	D		C Groove Width		
	±	Gland Depth	±	Hydraulic +0.13/-0.00	Pneumatic ± 0.13
1.00	0.08	0.75	0.02	1.45	1.20
1.20	0.08	0.90	0.02	1.75	1.45
1.50	0.08	1.13	0.02	2.20	1.80
1.60	0.08	1.20	0.03	2.35	1.90
1.78 - 1.80	0.08	1.34	0.03	2.60	2.15
1.90	0.08	1.43	0.03	2.75	2.30
2.00	0.08	1.51	0.04	2.90	2.40
2.40	0.08	1.82	0.04	3.20	2.80
2.50	0.08	1.90	0.04	3.30	2.90
2.62	0.08	1.99	0.04	3.50	3.05
3.00	0.08	2.27	0.04	3.90	3.45
3.50 - 3.53	0.10	2.67	0.05	4.60	4.05
3.60	0.10	2.72	0.05	4.70	4.10
4.00	0.10	3.03	0.06	5.25	4.60
4.50	0.10	3.60	0.06	6.10	5.10
5.00	0.13	4.00	0.06	6.80	5.70
5.33	0.13	4.26	0.08	7.25	6.05
5.50	0.13	4.40	0.08	7.45	6.25
5.70	0.13	4.56	0.08	7.75	6.50
6.00	0.13	4.98	0.08	8.00	6.75
6.99	0.15	5.80	0.10	9.05	7.85
7.00	0.15	5.81	0.10	9.05	7.90
7.50	0.15	6.23	0.10	9.70	8.40
8.00	0.15	6.64	0.10	10.35	9.00
8.40	0.15	6.97	0.15	10.90	9.45

Reciprocating Applications

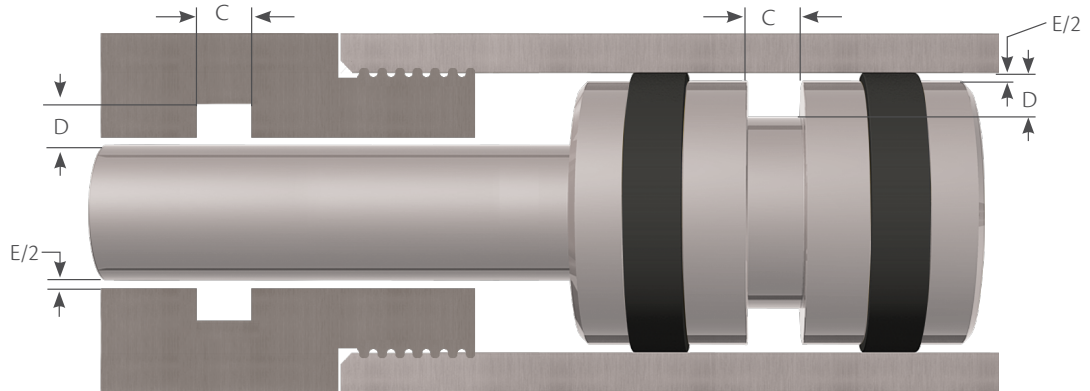

Information is based on DIN. 3771.

O-Ring C/S	±	D Gland Depth	±	E Diametrical Clearance	C Groove Width +0.13/-0.00	Max. Eccentricity
1.00	0.08	0.80	0.02	0.10	1.35	0.05
1.20	0.08	0.96	0.02	0.10	1.60	0.05
1.50	0.08	1.20	0.02	0.10	2.00	0.05
1.60	0.08	1.28	0.03	0.10	2.10	0.05
1.78 - 1.80	0.08	1.42	0.03	0.10	2.40	0.05
1.90	0.08	1.52	0.03	0.10	2.50	0.05
2.00	0.08	1.60	0.04	0.10	2.65	0.05
2.40	0.08	2.06	0.04	0.10	3.25	0.05
2.50	0.08	2.15	0.04	0.10	3.40	0.05
2.62	0.08	2.25	0.04	0.10	3.55	0.05
3.00	0.08	2.61	0.04	0.15	4.05	0.07
3.50 - 3.53	0.10	3.07	0.05	0.15	4.75	0.07
3.60	0.10	3.13	0.05	0.15	4.85	0.07
4.00	0.10	3.48	0.05	0.15	5.40	0.07
4.50	0.10	3.99	0.05	0.15	6.00	0.07
5.00	0.13	4.44	0.05	0.15	6.70	0.10
5.33- 5.34	0.13	4.73	0.05	0.15	7.15	0.10
5.50	0.13	4.88	0.05	0.15	7.40	0.10
5.70	0.13	5.06	0.05	0.15	7.60	0.10
6.00	0.13	5.19	0.05	0.18	8.15	0.13
6.99	0.15	6.05	0.05	0.18	9.50	0.13
7.00	0.15	6.06	0.05	0.18	9.55	0.13
7.50	0.15	6.49	0.05	0.18	10.20	0.13
8.00	0.18	6.92	0.05	0.18	10.90	0.13
8.40	0.18	7.27	0.05	0.18	11.45	0.13
9.00	0.20	7.92	0.05	0.18	12.10	0.13
10.00	0.20	8.80	0.05	0.18	13.40	0.13

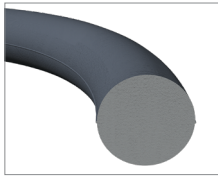

Cross reference column refers to JIS B 2401 (Japanese Industrial Standard) O-rings. These are organized into the following four series:

- P Series – Moving (dynamic)
- G Series – Fixed (static)
- S Series – Special Sizes
- V Series – Vacuum Flange

Part Number	C/S	ID	Cross Ref. #
1000115	1.00	1.15	
1000125	1.00	1.25	
100015	1.00	1.50	
100018	1.00	1.80	
10002	1.00	2.00	
100025	1.00	2.50	
100027	1.00	2.70	
10003	1.00	3.00	
100033	1.00	3.30	
100035	1.00	3.50	
10004	1.00	4.00	
100045	1.00	4.50	
10005	1.00	5.00	
100055	1.00	5.50	
10006	1.00	6.00	
100065	1.00	6.50	
10007	1.00	7.00	
100072	1.00	7.20	
100075	1.00	7.50	
10008	1.00	8.00	
100085	1.00	8.50	
10009	1.00	9.00	
100095	1.00	9.50	
10010	1.00	10.00	
100105	1.00	10.50	
10011	1.00	11.00	
100115	1.00	11.50	
10012	1.00	12.00	
100125	1.00	12.50	
10013	1.00	13.00	
100135	1.00	13.50	
10014	1.00	14.00	
100145	1.00	14.50	
10015	1.00	15.00	
100155	1.00	15.50	
10016	1.00	16.00	
100165	1.00	16.50	
10017	1.00	17.00	
10018	1.00	18.00	
100185	1.00	18.50	
10019	1.00	19.00	

Part Number	C/S	ID	Cross Ref. #
100195	1.00	19.50	
10020	1.00	20.00	
100205	1.00	20.50	
10021	1.00	21.00	
100215	1.00	21.50	
10022	1.00	22.00	
100225	1.00	22.50	
10023	1.00	23.00	
100235	1.00	23.50	
10024	1.00	24.00	
100245	1.00	24.50	
10025	1.00	25.00	
10028	1.00	28.00	
100294	1.00	29.40	
100299	1.00	29.90	
100305	1.00	30.50	
100318	1.00	31.80	
10032	1.00	32.00	
10039	1.00	39.00	
10042	1.00	42.00	
10060	1.00	60.00	
-001	1.02	0.74	
120025	1.20	2.50	
120026	1.20	2.60	
120035	1.20	3.50	
12005	1.20	5.00	
12024	1.20	24.00	
12026	1.20	26.00	
12028	1.20	28.00	
12035	1.20	35.00	
12040	1.20	40.00	
120535	1.20	53.50	
12098	1.20	98.00	
-002	1.27	1.07	
150018	1.50	1.80	
1500185	1.50	1.85	
15002	1.50	2.00	
150025	1.50	2.50	S3
150028	1.50	2.80	
15003	1.50	3.00	
150035	1.50	3.50	S4

Part Number	C/S	ID	Cross Ref. #
15004	1.50	4.00	
150045	1.50	4.50	S5
15005	1.50	5.00	
150055	1.50	5.50	S6
15006	1.50	6.00	
150065	1.50	6.50	S7
15007	1.50	7.00	
150075	1.50	7.50	S8
15008	1.50	8.00	
150085	1.50	8.50	S9
15009	1.50	9.00	
150095	1.50	9.50	S10
15010	1.50	10.00	
150105	1.50	10.50	
150107	1.50	10.70	S11.2
15011	1.50	11.00	
150115	1.50	11.50	S12
15012	1.50	12.00	S12.5
150125	1.50	12.50	
15013	1.50	13.00	
1501325	1.50	13.25	
150135	1.50	13.50	S14
15014	1.50	14.00	
15015	1.50	15.00	
150155	1.50	15.50	S16
15016	1.50	16.00	
150165	1.50	16.50	
15017	1.50	17.00	
150175	1.50	17.50	S18
15018	1.50	18.00	
150185	1.50	18.50	
15019	1.50	19.00	
150195	1.50	19.50	S20
15020	1.50	20.00	
150205	1.50	20.50	
15021	1.50	21.00	
150215	1.50	21.5	S22
15022	1.50	22.00	
150225	1.50	22.50	
15023	1.50	23.00	
150235	1.50	23.50	

Part Number	C/S	ID	Cross Ref. #
15024	1.50	24.00	
150245	1.50	24.50	
15025	1.50	25.00	
150255	1.50	25.50	
15026	1.50	26.00	
150265	1.50	26.50	
15027	1.50	27.00	
150275	1.50	27.50	
15028	1.50	28.00	
150285	1.50	28.50	
15029	1.50	29.00	
150295	1.50	29.50	
15030	1.50	30.00	
150305	1.50	30.50	
15031	1.50	31.00	
150315	1.50	31.50	
15032	1.50	32.00	
150325	1.50	32.50	
15033	1.50	33.00	
150335	1.50	33.50	
15034	1.50	34.00	
150345	1.50	34.50	
15035	1.50	35.00	
150355	1.50	35.50	
15036	1.50	36.00	
150365	1.50	36.50	
15037	1.50	37.00	
150375	1.50	37.50	
15038	1.50	38.00	
150385	1.50	38.50	
15039	1.50	39.00	
150395	1.50	39.50	
15040	1.50	40.00	
15041	1.50	41.00	
15042	1.50	42.00	
15043	1.50	43.00	
15044	1.50	44.00	
15045	1.50	45.00	
15046	1.50	46.00	
15047	1.50	47.00	
15048	1.50	48.00	
15049	1.50	49.00	
15050	1.50	50.00	
15051	1.50	51.00	
15052	1.50	52.00	
15053	1.50	53.00	
15054	1.50	54.00	
15055	1.50	55.00	

Part Number	C/S	ID	Cross Ref. #
15056	1.50	56.00	
15057	1.50	57.00	
15058	1.50	58.00	
15059	1.50	59.00	
15060	1.50	60.00	
15061	1.50	61.00	
15062	1.50	62.00	
15063	1.50	63.00	
15064	1.50	64.00	
15065	1.50	65.00	
15066	1.50	66.00	
15067	1.50	67.00	
15068	1.50	68.00	
15069	1.50	69.00	
15070	1.50	70.00	
15071	1.50	71.00	
15072	1.50	72.00	
15073	1.50	73.00	
15074	1.50	74.00	
15075	1.50	75.00	
15076	1.50	76.00	
15077	1.50	77.00	
15078	1.50	78.00	
15079	1.50	79.00	
15080	1.50	80.00	
15081	1.50	81.00	
15082	1.50	82.00	
15083	1.50	83.00	
15084	1.50	84.00	
15085	1.50	85.00	
15086	1.50	86.00	
15087	1.50	87.00	
15088	1.50	88.00	
15089	1.50	89.00	
15090	1.50	90.00	
15091	1.50	91.00	
15092	1.50	92.00	
15093	1.50	93.00	
15094	1.50	94.00	
15095	1.50	95.00	
15096	1.50	96.00	
15097	1.50	97.00	
15098	1.50	98.00	
15099	1.50	99.00	
15100	1.50	100.00	
15105	1.50	105.00	
15145	1.50	145.00	
-003	1.52	1.42	

Part Number	C/S	ID	Cross Ref. #
160022	1.60	2.20	
1600275	1.60	2.75	
160028	1.60	2.80	
160031	1.60	3.10	
160032	1.60	3.20	
160037	1.60	3.70	
160041	1.60	4.10	
160047	1.60	4.70	
160050	1.60	5.00	
160051	1.60	5.10	
160061	1.60	6.10	
160068	1.60	6.80	
160071	1.60	7.10	
160081	1.60	8.10	
160091	1.60	9.10	
160101	1.60	10.10	
160111	1.60	11.10	
160121	1.60	12.10	
160131	1.60	13.10	
160141	1.60	14.10	
160151	1.60	15.10	
160161	1.60	16.10	
160171	1.60	17.10	
160181	1.60	18.10	
160191	1.60	19.10	
160203	1.60	20.30	
160211	1.60	21.10	
160221	1.60	22.10	
160251	1.60	25.10	
160271	1.60	27.10	
160291	1.60	29.10	
160321	1.60	32.10	
160351	1.60	35.10	
160371	1.60	37.10	
160511	1.60	51.10	
160860	1.60	86.00	
160966	1.60	96.60	
16115	1.60	115.00	
-004	1.78	1.78	
-005	1.78	2.57	
-006	1.78	2.90	
-007	1.78	3.68	
-008	1.78	4.47	
-009	1.78	5.28	
-010	1.78	6.07	
-011	1.78	7.65	
-012	1.78	9.25	
-013	1.78	10.82	

Part Number	C/S	ID	Cross Ref. #
-014	1.78	12.42	
-015	1.78	14.00	
-016	1.78	15.60	
-017	1.78	17.17	
-018	1.78	18.77	
-019	1.78	20.35	
-020	1.78	21.95	
-021	1.78	23.52	
-022	1.78	25.12	
-023	1.78	26.70	
-024	1.78	28.30	
-025	1.78	29.87	
-026	1.78	31.47	
-027	1.78	33.05	
-028	1.78	34.65	
-029	1.78	37.82	
-030	1.78	41.00	
-031	1.78	44.17	
-032	1.78	47.35	
-033	1.78	50.52	
-034	1.78	53.70	
-035	1.78	56.87	
-036	1.78	60.05	
-037	1.78	63.22	
-038	1.78	66.40	
-039	1.78	69.57	
-040	1.78	72.75	
-041	1.78	75.92	
-042	1.78	82.27	
-043	1.78	88.62	
-044	1.78	94.97	
-045	1.78	101.32	
-046	1.78	107.67	
-047	1.78	114.02	
-048	1.78	120.37	
-049	1.78	126.72	
-050	1.78	133.07	
180018	1.80	1.80	
18002	1.80	2.00	
1800224	1.80	2.24	
180025	1.80	2.50	
180028	1.80	2.80	
1800315	1.80	3.15	
1800355	1.80	3.55	
1800375	1.80	3.75	
18004	1.80	4.00	
180045	1.80	4.50	
1800487	1.80	4.87	

Part Number	C/S	ID	Cross Ref. #
18005	1.80	5.00	
1800515	1.80	5.15	
180053	1.80	5.30	
180056	1.80	5.60	
18006	1.80	6.00	
180063	1.80	6.30	
180067	1.80	6.70	
180069	1.80	6.90	
180071	1.80	7.10	
180075	1.80	7.50	
18008	1.80	8.00	
180085	1.80	8.50	
1800876	1.80	8.76	
18009	1.80	9.00	
180095	1.80	9.50	
18010	1.80	10.00	
180106	1.80	10.60	
180112	1.80	11.20	
180118	1.80	11.80	
180125	1.80	12.50	
180132	1.80	13.20	
18014	1.80	14.00	
18015	1.80	15.00	
18016	1.80	16.00	
18017	1.80	17.00	
190024	1.90	2.40	
190026	1.90	2.60	
190028	1.90	2.80	P3
190034	1.90	3.40	
190037	1.90	3.70	
190038	1.90	3.80	P4
190042	1.90	4.20	
190048	1.90	4.80	P5
190049	1.90	4.90	
190057	1.90	5.70	
190058	1.90	5.80	P6
190064	1.90	6.40	
190068	1.90	6.80	P7
190072	1.90	7.20	
190078	1.90	7.80	P8
19008	1.90	8.00	
190088	1.90	8.80	P9
190089	1.90	8.90	
190098	1.90	9.80	P10
20002	2.00	2.00	
200025	2.00	2.50	
200026	2.00	2.60	
20003	2.00	3.00	

Part Number	C/S	ID	Cross Ref. #
200035	2.00	3.50	
20004	2.00	4.00	
200045	2.00	4.50	
200046	2.00	4.60	
20005	2.00	5.00	
200055	2.00	5.50	
20006	2.00	6.00	
200065	2.00	6.50	
20007	2.00	7.00	
200075	2.00	7.50	
20008	2.00	8.00	
200085	2.00	8.50	
20009	2.00	9.00	
200094	2.00	9.40	
20010	2.00	10.00	
200105	2.00	10.50	
20011	2.00	11.00	
200115	2.00	11.50	
20012	2.00	12.00	
200125	2.00	12.50	
20013	2.00	13.00	
200135	2.00	13.50	
20014	2.00	14.00	
200145	2.00	14.50	
20015	2.00	15.00	
200155	2.00	15.50	
20016	2.00	16.00	
200165	2.00	16.50	
20017	2.00	17.00	
200175	2.00	17.50	
20018	2.00	18.00	
200185	2.00	18.50	
20019	2.00	19.00	
200195	2.00	19.50	
20020	2.00	20.00	
200205	2.00	20.50	
20021	2.00	21.00	
200215	2.00	21.50	
200219	2.00	21.90	S22.4
20022	2.00	22.00	
200225	2.00	22.50	
20023	2.00	23.00	
200235	2.00	23.50	S24
20024	2.00	24.00	
200245	2.00	24.50	S25
20025	2.00	25.00	
200255	2.00	25.50	S26
20026	2.00	26.00	

Part Number	C/S	ID	Cross Ref. #
200265	2.00	26.50	
20027	2.00	27.00	
200275	2.00	27.50	S28
20028	2.00	28.00	
200285	2.00	28.50	S29
20029	2.00	29.00	
200295	2.00	29.50	S30
20030	2.00	30.00	
200305	2.00	30.50	
20031	2.00	31.00	S31.5
200315	2.00	31.50	S32
20032	2.00	32.00	
200325	2.00	32.50	
20033	2.00	33.00	
200335	2.00	33.50	S34
20034	2.00	34.00	
200345	2.00	34.50	S35
20035	2.00	35.00	S35.5
200355	2.00	35.50	S36
20036	2.00	36.00	
200365	2.00	36.50	
20037	2.00	37.00	
200375	2.00	37.50	S38
20038	2.00	38.00	
20039	2.00	39.00	
200395	2.00	39.50	S40
20040	2.00	40.00	
20041	2.00	41.00	
200415	2.00	41.50	S42
20042	2.00	42.00	
20043	2.00	43.00	
200435	2.00	43.50	S44
20044	2.00	44.00	
200445	2.00	44.50	S45
20045	2.00	45.00	
200455	2.00	45.50	S46
20046	2.00	46.00	
20047	2.00	47.00	
200475	2.00	47.50	S48
20048	2.00	48.00	
20049	2.00	49.00	
200495	2.00	49.50	S50
20050	2.00	50.00	
20051	2.00	51.00	
20052	2.00	52.00	
200525	2.00	52.50	S53
20053	2.00	53.00	
20054	2.00	54.00	

Part Number	C/S	ID	Cross Ref. #
200545	2.00	54.50	S55
20055	2.00	55.00	
200555	2.00	55.50	S56
20056	2.00	56.00	
20057	2.00	57.00	
20058	2.00	58.00	
20059	2.00	59.00	
200595	2.00	59.50	S60
20060	2.00	60.00	
20061	2.00	61.00	
20062	2.00	62.00	
200625	2.00	62.50	S63
20063	2.00	63.00	
20064	2.00	64.00	
200645	2.00	64.50	S65
20065	2.00	65.00	
20066	2.00	66.00	
200665	2.00	66.50	S67
20067	2.00	67.00	
20068	2.00	68.00	
20069	2.00	69.00	
200695	2.00	69.50	S70
20070	2.00	70.00	
200705	2.00	70.50	S71
20071	2.00	71.00	
20072	2.00	72.00	
20073	2.00	73.00	
20074	2.00	74.00	
200745	2.00	74.50	S75
20075	2.00	75.00	
20076	2.00	76.00	
20077	2.00	77.00	
20078	2.00	78.00	
20079	2.00	79.00	
200795	2.00	79.50	S80
20080	2.00	80.00	
20081	2.00	81.00	
20082	2.00	82.00	
20083	2.00	83.00	
20084	2.00	84.00	
200845	2.00	84.50	S85
20085	2.00	85.00	
20086	2.00	86.00	
20087	2.00	87.00	
20088	2.00	88.00	
20089	2.00	89.00	
200895	2.00	89.50	S90
20090	2.00	90.00	

Part Number	C/S	ID	Cross Ref. #
20091	2.00	91.00	
20092	2.00	92.00	
20093	2.00	93.00	
20094	2.00	94.00	
200945	2.00	94.50	S95
20095	2.00	95.00	
20096	2.00	96.00	
20097	2.00	97.00	
20098	2.00	98.00	
20099	2.00	99.00	
200995	2.00	99.50	S100
20100	2.00	100.00	
20102	2.00	102.00	
201045	2.00	104.50	S105
20105	2.00	105.00	
20109	2.00	109.00	
201095	2.00	109.50	S110
20110	2.00	110.00	
201115	2.00	111.50	S112
201145	2.00	114.50	S115
20115	2.00	115.00	
201195	2.00	119.50	S120
20120	2.00	120.00	
201245	2.00	124.50	S125
201256	2.00	125.60	
201295	2.00	129.50	S130
20130	2.00	130.00	
201315	2.00	131.50	S132
201345	2.00	134.50	S135
201395	2.00	139.50	S140
20140	2.00	140.00	
201445	2.00	144.50	S145
201495	2.00	149.50	S150
20165	2.00	165.00	
20180	2.00	180.00	
20194	2.00	194.00	
240033	2.40	3.30	
240036	2.40	3.60	
240043	2.40	4.30	
240046	2.40	4.60	
240053	2.40	5.30	
240055	2.40	5.50	
240056	2.40	5.60	
240063	2.40	6.30	
240066	2.40	6.60	
240073	2.40	7.30	
240075	2.40	7.50	
240076	2.40	7.60	

Part Number	C/S	ID	Cross Ref. #
24008	2.40	8.00	
240083	2.40	8.30	
240086	2.40	8.60	
240093	2.40	9.30	
240096	2.40	9.60	
240098	2.40	9.80	P10A
240103	2.40	10.30	
240105	2.40	10.50	
240106	2.40	10.60	
240108	2.40	10.80	P11
24011	2.40	11.00	P11.2
240113	2.40	11.30	
240115	2.40	11.50	
240116	2.40	11.60	
240118	2.40	11.80	P12
240123	2.40	12.30	P12.5
240126	2.40	12.60	
240133	2.40	13.30	
240135	2.40	13.50	
240136	2.40	13.60	
240138	2.40	13.80	P14
240143	2.40	14.30	
240145	2.40	14.50	
240146	2.40	14.60	
240148	2.40	14.80	P15
240153	2.40	15.30	
240155	2.40	15.50	
240156	2.40	15.60	
240158	2.40	15.80	P16
240159	2.40	15.90	
240163	2.40	16.30	
240166	2.40	16.60	
240173	2.40	17.30	
240175	2.40	17.50	
240176	2.40	17.60	
240178	2.40	17.80	P18
240183	2.40	18.30	
240186	2.40	18.60	
240193	2.40	19.30	
240196	2.40	19.60	
240198	2.40	19.80	P20
240203	2.40	20.30	
240205	2.40	20.50	
240208	2.40	20.80	P21
240213	2.40	21.30	
240215	2.40	21.50	
240216	2.40	21.60	
240218	2.40	21.80	P22

Part Number	C/S	ID	Cross Ref. #
240223	2.40	22.30	
240226	2.40	22.60	
240233	2.40	23.30	
240235	2.40	23.50	
240236	2.40	23.60	
240243	2.40	24.30	
240245	2.40	24.50	
240246	2.40	24.60	
24025	2.40	25.00	
240253	2.40	25.30	
240256	2.40	25.60	
240273	2.40	27.30	
240275	2.40	27.50	
240276	2.40	27.60	
240296	2.40	29.60	
240303	2.40	30.30	
240316	2.40	31.60	
240333	2.40	33.30	
240346	2.40	34.60	
240365	2.40	36.50	
240376	2.40	37.60	
240396	2.40	39.60	
240416	2.40	41.60	
240446	2.40	44.60	
240476	2.40	47.60	
240496	2.40	49.60	
240516	2.40	51.60	
240546	2.40	54.60	
240576	2.40	57.60	
240596	2.40	59.60	
240616	2.40	61.60	
240646	2.40	64.60	
240676	2.40	67.60	
240696	2.40	69.60	
25004	2.50	4.00	
250046	2.50	4.60	
25005	2.50	5.00	
250055	2.50	5.50	
25006	2.50	6.00	
250065	2.50	6.50	
25007	2.50	7.00	
250075	2.50	7.50	
25008	2.50	8.00	
250085	2.50	8.50	
25009	2.50	9.00	
250095	2.50	9.50	
25010	2.50	10.00	
250105	2.50	10.50	

Part Number	C/S	ID	Cross Ref. #
25011	2.50	11.00	
250115	2.50	11.50	
25012	2.50	12.00	
250125	2.50	12.50	
25013	2.50	13.00	
250135	2.50	13.50	
25014	2.50	14.00	
250145	2.50	14.50	
25015	2.50	15.00	
250155	2.50	15.50	
25016	2.50	16.00	
250165	2.50	16.50	
25017	2.50	17.00	
250175	2.50	17.50	
25018	2.50	18.00	
250185	2.50	18.50	
25019	2.50	19.00	
250195	2.50	19.50	
25020	2.50	20.00	
250205	2.50	20.50	
25021	2.50	21.00	
250215	2.50	21.50	
25022	2.50	22.00	
250225	2.50	22.50	
25023	2.50	23.00	
250235	2.50	23.50	
25024	2.50	24.00	
250245	2.50	24.50	
25025	2.50	25.00	
250255	2.50	25.50	
25026	2.50	26.00	
250265	2.50	26.50	
25027	2.50	27.00	
250275	2.50	27.50	
25028	2.50	28.00	
250285	2.50	28.50	
25029	2.50	29.00	
250295	2.50	29.50	
25030	2.50	30.00	
250305	2.50	30.50	
25031	2.50	31.00	
250315	2.50	31.50	
25032	2.50	32.00	
250325	2.50	32.50	
25033	2.50	33.00	
250335	2.50	33.50	
25034	2.50	34.00	
250345	2.50	34.50	

Part Number	C/S	ID	Cross Ref. #
25035	2.50	35.00	
250355	2.50	35.50	
25036	2.50	36.00	
250365	2.50	36.50	
25037	2.50	37.00	
250375	2.50	37.50	
25038	2.50	38.00	
250385	2.50	38.50	
25039	2.50	39.00	
250395	2.50	39.50	
25040	2.50	40.00	
25041	2.50	41.00	
25042	2.50	42.00	
25043	2.50	43.00	
25044	2.50	44.00	
25045	2.50	45.00	
25046	2.50	46.00	
25047	2.50	47.00	
25048	2.50	48.00	
25049	2.50	49.00	
25050	2.50	50.00	
25051	2.50	51.00	
25052	2.50	52.00	
25053	2.50	53.00	
25054	2.50	54.00	
25055	2.50	55.00	
25056	2.50	56.00	
25057	2.50	57.00	
25058	2.50	58.00	
25059	2.50	59.00	
25060	2.50	60.00	
25061	2.50	61.00	
25062	2.50	62.00	
25063	2.50	63.00	
25064	2.50	64.00	
25065	2.50	65.00	
25066	2.50	66.00	
25067	2.50	67.00	
25068	2.50	68.00	
25069	2.50	69.00	
25070	2.50	70.00	
25071	2.50	71.00	
25072	2.50	72.00	
25073	2.50	73.00	
25074	2.50	74.00	
25075	2.50	75.00	
25076	2.50	76.00	
25077	2.50	77.00	

Part Number	C/S	ID	Cross Ref. #
25078	2.50	78.00	
25079	2.50	79.00	
25080	2.50	80.00	
25081	2.50	81.00	
25082	2.50	82.00	
25083	2.50	83.00	
25084	2.50	84.00	
25085	2.50	85.00	
25086	2.50	86.00	
25087	2.50	87.00	
25088	2.50	88.00	
25089	2.50	89.00	
25090	2.50	90.00	
25091	2.50	91.00	
25092	2.50	92.00	
25093	2.50	93.00	
25094	2.50	94.00	
25095	2.50	95.00	
25096	2.50	96.00	
25097	2.50	97.00	
25098	2.50	98.00	
25099	2.50	99.00	
25100	2.50	100.00	
25101	2.50	101.00	
25102	2.50	102.00	
25103	2.50	103.00	
25104	2.50	104.00	
25105	2.50	105.00	
25106	2.50	106.00	
25107	2.50	107.00	
25108	2.50	108.00	
25109	2.50	109.00	
25110	2.50	110.00	
25111	2.50	111.00	
25112	2.50	112.00	
25113	2.50	113.00	
25114	2.50	114.00	
25115	2.50	115.00	
25116	2.50	116.00	
25117	2.50	117.00	
25118	2.50	118.00	
25119	2.50	119.00	
25120	2.50	120.00	
25121	2.50	121.00	
25122	2.50	122.00	
25123	2.50	123.00	
25124	2.50	124.00	
25125	2.50	125.00	

Part Number	C/S	ID	Cross Ref. #
25126	2.50	126.00	
25127	2.50	127.00	
25128	2.50	128.00	
25129	2.50	129.00	
25130	2.50	130.00	
25131	2.50	131.00	
25132	2.50	132.00	
25133	2.50	133.00	
25134	2.50	134.00	
25135	2.50	135.00	
25136	2.50	136.00	
25137	2.50	137.00	
25138	2.50	138.00	
25139	2.50	139.00	
25140	2.50	140.00	
25141	2.50	141.00	
25142	2.50	142.00	
25143	2.50	143.00	
25144	2.50	144.00	
25145	2.50	145.00	
25146	2.50	146.00	
25147	2.50	147.00	
25148	2.50	148.00	
25149	2.50	149.00	
25150	2.50	150.00	
-102	2.62	1.24	
-103	2.62	2.06	
-104	2.62	2.84	
-105	2.62	3.63	
-106	2.62	4.42	
-107	2.62	5.23	
-108	2.62	6.02	
-109	2.62	7.59	
-110	2.62	9.19	
-111	2.62	10.77	
-112	2.62	12.37	
-113	2.62	13.94	
-114	2.62	15.54	
-115	2.62	17.12	
-116	2.62	18.72	
-117	2.62	20.30	
-118	2.62	21.89	
-119	2.62	23.47	
-120	2.62	25.07	
-121	2.62	26.64	
-122	2.62	28.24	
-123	2.62	29.82	
-124	2.62	31.42	

Part Number	C/S	ID	Cross Ref. #
-125	2.62	32.99	
-126	2.62	34.59	
-127	2.62	36.17	
-128	2.62	37.77	
-129	2.62	39.34	
-130	2.62	40.94	
-131	2.62	42.52	
-132	2.62	44.12	
-133	2.62	45.69	
-134	2.62	47.29	
-135	2.62	48.90	
-136	2.62	50.47	
-137	2.62	52.07	
-138	2.62	53.64	
-139	2.62	55.25	
-140	2.62	56.82	
-141	2.62	58.42	
-142	2.62	59.99	
-143	2.62	61.60	
-144	2.62	63.17	
-145	2.62	64.77	
-146	2.62	66.34	
-147	2.62	67.95	
-148	2.62	69.52	
-149	2.62	71.12	
-150	2.62	72.69	
-151	2.62	75.87	
-152	2.62	82.22	
-153	2.62	88.57	
-154	2.62	94.92	
-155	2.62	101.27	
-156	2.62	107.62	
-157	2.62	113.97	
-158	2.62	120.32	
-159	2.62	126.67	
-160	2.62	133.02	
-161	2.62	139.37	
-162	2.62	145.72	
-163	2.62	152.07	
-164	2.62	158.42	
-165	2.62	164.77	
-166	2.62	171.12	
-167	2.62	177.47	
-168	2.62	183.82	
-169	2.62	190.17	
-170	2.62	196.52	
-171	2.62	202.87	
-172	2.62	209.22	
-173	2.62	215.57	

Part Number	C/S	ID	Cross Ref. #
-174	2.62	221.92	
-175	2.62	228.27	
-176	2.62	234.62	
-177	2.62	240.97	
-178	2.62	247.32	
265014	2.65	14.00	
265015	2.65	15.00	
265016	2.65	16.00	
265017	2.65	17.00	
265018	2.65	18.00	
265019	2.65	19.00	
265020	2.65	20.00	
2650212	2.65	21.20	
2650224	2.65	22.40	
2650236	2.65	23.60	
265025	2.65	25.00	
2650258	2.65	25.80	
2650265	2.65	26.50	
265028	2.65	28.00	
265030	2.65	30.00	
2650315	2.65	31.50	
265032	2.65	32.00	
2650325	2.65	32.50	
2650335	2.65	33.50	
2650345	2.65	34.50	
2650355	2.65	35.50	
2650365	2.65	36.50	
2650375	2.65	37.50	
2650387	2.65	38.70	
300035	3.00	3.50	
30004	3.00	4.00	
300045	3.00	4.50	
30005	3.00	5.00	
300055	3.00	5.50	
30006	3.00	6.00	
300065	3.00	6.50	
30007	3.00	7.00	
300075	3.00	7.50	
30008	3.00	8.00	
300085	3.00	8.50	
30009	3.00	9.00	
300095	3.00	9.50	
30010	3.00	10.00	
300105	3.00	10.50	
30011	3.00	11.00	
300115	3.00	11.50	
30012	3.00	12.00	
300125	3.00	12.50	
30013	3.00	13.00	

Part Number	C/S	ID	Cross Ref. #
300135	3.00	13.50	
30014	3.00	14.00	
300145	3.00	14.50	
30015	3.00	15.00	
300155	3.00	15.50	
30016	3.00	16.00	
300165	3.00	16.50	
30017	3.00	17.00	
300175	3.00	17.50	
30018	3.00	18.00	
300182	3.00	18.20	
300185	3.00	18.50	
30019	3.00	19.00	
300192	3.00	19.20	
300195	3.00	19.50	
30020	3.00	20.00	
300205	3.00	20.50	
30021	3.00	21.00	
300215	3.00	21.50	
30022	3.00	22.00	
300222	3.00	22.20	
300225	3.00	22.50	
30023	3.00	23.00	
300235	3.00	23.50	
30024	3.00	24.00	
300242	3.00	24.20	
300245	3.00	24.50	
300246	3.00	24.60	
30025	3.00	25.00	
300252	3.00	25.20	
300255	3.00	25.50	
30026	3.00	26.00	
300262	3.00	26.20	
300265	3.00	26.50	
30027	3.00	27.00	
300275	3.00	27.50	
30028	3.00	28.00	
300285	3.00	28.50	
30029	3.00	29.00	
300292	3.00	29.20	
300295	3.00	29.50	
30030	3.00	30.00	
300302	3.00	30.20	
300305	3.00	30.50	
30031	3.00	31.00	
300315	3.00	31.50	
30032	3.00	32.00	
300322	3.00	32.20	
300325	3.00	32.50	

Part Number	C/S	ID	Cross Ref. #
30033	3.00	33.00	
300335	3.00	33.50	
30034	3.00	34.00	
300342	3.00	34.20	
300345	3.00	34.50	
30035	3.00	35.00	
300355	3.00	35.50	
30036	3.00	36.00	
300362	3.00	36.20	
300365	3.00	36.50	
30037	3.00	37.00	
300372	3.00	37.20	
300375	3.00	37.50	
30038	3.00	38.00	
300385	3.00	38.50	
30039	3.00	39.00	
300392	3.00	39.20	
300395	3.00	39.50	
30040	3.00	40.00	
300402	3.00	40.20	
30041	3.00	41.00	
300415	3.00	41.50	
30042	3.00	42.00	
300422	3.00	42.20	
300425	3.00	42.50	
30043	3.00	43.00	
30044	3.00	44.00	
300442	3.00	44.20	
300445	3.00	44.50	
30045	3.00	45.00	
30046	3.00	46.00	
30047	3.00	47.00	
30048	3.00	48.00	
30049	3.00	49.00	
300495	3.00	49.50	
30050	3.00	50.00	
300505	3.00	50.50	
30051	3.00	51.00	
30052	3.00	52.00	
30053	3.00	53.00	
30054	3.00	54.00	
300542	3.00	54.20	
300545	3.00	54.50	
30055	3.00	55.00	
30056	3.00	56.00	
300562	3.00	56.20	
30057	3.00	57.00	
30058	3.00	58.00	
30059	3.00	59.00	

Part Number	C/S	ID	Cross Ref. #
300595	3.00	59.50	
30060	3.00	60.00	
30061	3.00	61.00	
30062	3.00	62.00	
300622	3.00	62.20	
30063	3.00	63.00	
30064	3.00	64.00	
300645	3.00	64.50	
30065	3.00	65.00	
30066	3.00	66.00	
30067	3.00	67.00	
30068	3.00	68.00	
30069	3.00	69.00	
30070	3.00	70.00	
30071	3.00	71.00	
30072	3.00	72.00	
30073	3.00	73.00	
30074	3.00	74.00	
30075	3.00	75.00	
30076	3.00	76.00	
30077	3.00	77.00	
30078	3.00	78.00	
30079	3.00	79.00	
30080	3.00	80.00	
30081	3.00	81.00	
30082	3.00	82.00	
30083	3.00	83.00	
30084	3.00	84.00	
300845	3.00	84.50	
30085	3.00	85.00	
30086	3.00	86.00	
30087	3.00	87.00	
30088	3.00	88.00	
30089	3.00	89.00	
300895	3.00	89.50	
30090	3.00	90.00	
30091	3.00	91.00	
30092	3.00	92.00	
30093	3.00	93.00	
30094	3.00	94.00	
300945	3.00	94.50	
30095	3.00	95.00	
30096	3.00	96.00	
30097	3.00	97.00	
30098	3.00	98.00	
30099	3.00	99.00	
300995	3.00	99.50	
30100	3.00	100.00	
30101	3.00	101.00	

Part Number	C/S	ID	Cross Ref. #
30102	3.00	102.00	
30103	3.00	103.00	
30104	3.00	104.00	
301045	3.00	104.50	
30105	3.00	105.00	
30106	3.00	106.00	
30107	3.00	107.00	
30108	3.00	108.00	
30109	3.00	109.00	
301095	3.00	109.50	
30110	3.00	110.00	
30111	3.00	111.00	
30112	3.00	112.00	
30113	3.00	113.00	
30114	3.00	114.00	
301145	3.00	114.50	
30115	3.00	115.00	
30116	3.00	116.00	
30117	3.00	117.00	
30118	3.00	118.00	
30119	3.00	119.00	
301195	3.00	119.50	
30120	3.00	120.00	
30121	3.00	121.00	
30122	3.00	122.00	
30123	3.00	123.00	
30124	3.00	124.00	
301245	3.00	124.50	
30125	3.00	125.00	
30126	3.00	126.00	
301265	3.00	126.50	
30127	3.00	127.00	
30128	3.00	128.00	
30129	3.00	129.00	
301295	3.00	129.50	
30130	3.00	130.00	
30131	3.00	131.00	
30132	3.00	132.00	
30133	3.00	133.00	
30134	3.00	134.00	
301345	3.00	134.50	
30135	3.00	135.00	
30136	3.00	136.00	
30137	3.00	137.00	
30138	3.00	138.00	
30139	3.00	139.00	
301395	3.00	139.50	
30140	3.00	140.00	
30141	3.00	141.00	

Part Number	C/S	ID	Cross Ref. #
30142	3.00	142.00	
30143	3.00	143.00	
30144	3.00	144.00	
301445	3.00	144.50	
30145	3.00	145.00	
30146	3.00	146.00	
30147	3.00	147.00	
30148	3.00	148.00	
30149	3.00	149.00	
301495	3.00	149.50	
30150	3.00	150.00	
30151	3.00	151.00	
30152	3.00	152.00	
30153	3.00	153.00	
30154	3.00	154.00	
301545	3.00	154.50	
30155	3.00	155.00	
30156	3.00	156.00	
30157	3.00	157.00	
30158	3.00	158.00	
30159	3.00	159.00	
301595	3.00	159.50	
30160	3.00	160.00	
30161	3.00	161.00	
30162	3.00	162.00	
30163	3.00	163.00	
30164	3.00	164.00	
301645	3.00	164.50	
30165	3.00	165.00	
30166	3.00	166.00	
30167	3.00	167.00	
30168	3.00	168.00	
30169	3.00	169.00	
301695	3.00	169.50	
30170	3.00	170.00	
30171	3.00	171.00	
30172	3.00	172.00	
30173	3.00	173.00	
30174	3.00	174.00	
301745	3.00	174.50	
30175	3.00	175.00	
30176	3.00	176.00	
30177	3.00	177.00	
30178	3.00	178.00	
30179	3.00	179.00	
301795	3.00	179.50	
30180	3.00	180.00	

Part Number	C/S	ID	Cross Ref. #
30181	3.00	181.00	
30182	3.00	182.00	
30183	3.00	183.00	
301835	3.00	183.50	
30184	3.00	184.00	
301845	3.00	184.50	
30185	3.00	185.00	
30186	3.00	186.00	
30187	3.00	187.00	
30188	3.00	188.00	
30189	3.00	189.00	
301895	3.00	189.50	
30190	3.00	190.00	
30191	3.00	191.00	
30192	3.00	192.00	
30193	3.00	193.00	
30194	3.00	194.00	
301945	3.00	194.50	
30195	3.00	195.00	
30196	3.00	196.00	
30197	3.00	197.00	
30198	3.00	198.00	
30199	3.00	199.00	
301995	3.00	199.50	
30200	3.00	200.00	
310244	3.10	24.40	G25
310294	3.10	29.40	G30
310344	3.10	34.40	G35
310394	3.10	39.40	G40
310444	3.10	44.40	G45
310494	3.10	49.40	G50
310544	3.10	54.40	G 55
310594	3.10	59.40	G60
310644	3.10	64.40	G65
310694	3.10	69.40	G70
310744	3.10	74.40	G75
310794	3.10	79.40	G80
310844	3.10	84.40	G85
310894	3.10	89.40	G90
310944	3.10	94.40	G95
310994	3.10	99.40	G100
311044	3.10	104.40	G105
311094	3.10	109.40	G110
311144	3.10	114.40	G115
311194	3.10	119.40	G120
311244	3.10	124.40	G125
311294	3.10	129.40	G130

Part Number	C/S	ID	Cross Ref. #
311344	3.10	134.40	G135
311394	3.10	139.40	G140
311444	3.10	144.40	G145
35005	3.50	5.00	
35008	3.50	8.00	
35009	3.50	9.00	
350092	3.50	9.20	
35010	3.50	10.00	
35011	3.50	11.00	
35012	3.50	12.00	
35013	3.50	13.00	
35014	3.50	14.00	
35015	3.50	15.00	
35016	3.50	16.00	
35017	3.50	17.00	
350175	3.50	17.50	
35018	3.50	18.00	
35019	3.50	19.00	
35020	3.50	20.00	
35021	3.50	21.00	
350217	3.50	21.70	P22A
35022	3.50	22.00	
350221	3.50	22.10	P22.4
35023	3.50	23.00	
350237	3.50	23.70	P24
35024	3.50	24.00	
350247	3.50	24.70	P25
35025	3.50	25.00	
350252	3.50	25.20	P25.5
350257	3.50	25.70	P26
35026	3.50	26.00	
35027	3.50	27.00	
350277	3.50	27.70	P28
35028	3.50	28.00	
350287	3.50	28.70	P29
35029	3.50	29.00	
350292	3.50	29.20	P29.5
350297	3.50	29.70	P30
35030	3.50	30.00	
350305	3.50	30.50	
350307	3.50	30.70	P31
35031	3.50	31.00	
350312	3.50	31.20	P31.5
350317	3.50	31.70	P32
35032	3.50	32.00	
35033	3.50	33.00	
350337	3.50	33.70	P34

Part Number	C/S	ID	Cross Ref. #
35034	3.50	34.00	
350347	3.50	34.70	P35
35035	3.50	35.00	
350352	3.50	35.20	P35.5
350357	3.50	35.70	P36
35036	3.50	36.00	
35037	3.50	37.00	
350377	3.50	37.70	P38
35038	3.50	38.00	
350387	3.50	38.70	P39
35039	3.50	39.00	
350397	3.50	39.70	P40
35040	3.50	40.00	
350407	3.50	40.70	P41
35041	3.50	41.00	
350417	3.50	41.70	P42
35042	3.50	42.00	
35043	3.50	43.00	
350437	3.50	43.70	P44
35044	3.50	44.00	
350447	3.50	44.70	P45
35045	3.50	45.00	
350457	3.50	45.70	P46
35046	3.50	46.00	
35047	3.50	47.00	
350477	3.50	47.70	P48
35048	3.50	48.00	
350487	3.50	48.70	P49
35049	3.50	49.00	
350497	3.50	49.70	P50
35050	3.50	50.00	
35051	3.50	51.00	
35052	3.50	52.00	
35053	3.50	53.00	
35054	3.50	54.00	
35055	3.50	55.00	
35056	3.50	56.00	
35057	3.50	57.00	
35058	3.50	58.00	
35059	3.50	59.00	
35060	3.50	60.00	
35061	3.50	61.00	
35062	3.50	62.00	
35063	3.50	63.00	
35064	3.50	64.00	
35065	3.50	65.00	
35066	3.50	66.00	

Part Number	C/S	ID	Cross Ref. #
35067	3.50	67.00	
35068	3.50	68.00	
35069	3.50	69.00	
35070	3.50	70.00	
35071	3.50	71.00	
35072	3.50	72.00	
35073	3.50	73.00	
35074	3.50	74.00	
35075	3.50	75.00	
35076	3.50	76.00	
35077	3.50	77.00	
35078	3.50	78.00	
35079	3.50	79.00	
35080	3.50	80.00	
35081	3.50	81.00	
35082	3.50	82.00	
35083	3.50	83.00	
35084	3.50	84.00	
35085	3.50	85.00	
35086	3.50	86.00	
35087	3.50	87.00	
35088	3.50	88.00	
35089	3.50	89.00	
35090	3.50	90.00	
35091	3.50	91.00	
35092	3.50	92.00	
35093	3.50	93.00	
35094	3.50	94.00	
35095	3.50	95.00	
35096	3.50	96.00	
35097	3.50	97.00	
35098	3.50	98.00	
35099	3.50	99.00	
35100	3.50	100.00	
35101	3.50	101.00	
35102	3.50	102.00	
35103	3.50	103.00	
35104	3.50	104.00	
35105	3.50	105.00	
35106	3.50	106.00	
35107	3.50	107.00	
35108	3.50	108.00	
35109	3.50	109.00	
35110	3.50	110.00	
35111	3.50	111.00	
35112	3.50	112.00	
35113	3.50	113.00	

Part Number	C/S	ID	Cross Ref. #
35114	3.50	114.00	
35115	3.50	115.00	
35116	3.50	116.00	
35117	3.50	117.00	
35118	3.50	118.00	
35119	3.50	119.00	
35120	3.50	120.00	
35121	3.50	121.00	
35122	3.50	122.00	
35123	3.50	123.00	
35124	3.50	124.00	
35125	3.50	125.00	
35126	3.50	126.00	
35127	3.50	127.00	
35128	3.50	128.00	
35129	3.50	129.00	
35130	3.50	130.00	
35131	3.50	131.00	
35132	3.50	132.00	
35133	3.50	133.00	
35134	3.50	134.00	
35135	3.50	135.00	
35136	3.50	136.00	
35137	3.50	137.00	
35138	3.50	138.00	
35139	3.50	139.00	
35140	3.50	140.00	
35141	3.50	141.00	
35142	3.50	142.00	
35143	3.50	143.00	
35144	3.50	144.00	
35145	3.50	145.00	
35146	3.50	146.00	
35147	3.50	147.00	
35148	3.50	148.00	
35149	3.50	149.00	
35150	3.50	150.00	
35151	3.50	151.00	
35152	3.50	152.00	
35153	3.50	153.00	
35154	3.50	154.00	
35155	3.50	155.00	
35156	3.50	156.00	
35157	3.50	157.00	
35158	3.50	158.00	
35159	3.50	159.00	
35160	3.50	160.00	

Part Number	C/S	ID	Cross Ref. #
35161	3.50	161.00	
35162	3.50	162.00	
35163	3.50	163.00	
35164	3.50	164.00	
35165	3.50	165.00	
35166	3.50	166.00	
35167	3.50	167.00	
35168	3.50	168.00	
35169	3.50	169.00	
35170	3.50	170.00	
35171	3.50	171.00	
35172	3.50	172.00	
35173	3.50	173.00	
35174	3.50	174.00	
35175	3.50	175.00	
35176	3.50	176.00	
35177	3.50	177.00	
35178	3.50	178.00	
35179	3.50	179.00	
35180	3.50	180.00	
35181	3.50	181.00	
35182	3.50	182.00	
35183	3.50	183.00	
35184	3.50	184.00	
35185	3.50	185.00	
35186	3.50	186.00	
35187	3.50	187.00	
35188	3.50	188.00	
35189	3.50	189.00	
35190	3.50	190.00	
35191	3.50	191.00	
35192	3.50	192.00	
35193	3.50	193.00	
35194	3.50	194.00	
35195	3.50	195.00	
35196	3.50	196.00	
35197	3.50	197.00	
35198	3.50	198.00	
35199	3.50	199.00	
35200	3.50	200.00	
-201	3.53	4.34	
-202	3.53	5.94	
-203	3.53	7.52	
-204	3.53	9.12	
-205	3.53	10.69	
-206	3.53	12.29	

Part Number	C/S	ID	Cross Ref. #
-207	3.53	13.87	
-208	3.53	15.47	
-209	3.53	17.04	
-210	3.53	18.64	
-211	3.53	20.22	
-212	3.53	21.82	
-213	3.53	23.39	
-214	3.53	24.99	
-215	3.53	26.57	
-216	3.53	28.17	
-217	3.53	29.74	
-218	3.53	31.34	
-219	3.53	32.92	
-220	3.53	34.52	
-221	3.53	36.09	
-222	3.53	37.69	
-223	3.53	40.87	
-224	3.53	44.04	
-225	3.53	47.22	
-226	3.53	50.39	
-227	3.53	53.57	
-228	3.53	56.74	
-229	3.53	59.92	
-230	3.53	63.09	
-231	3.53	66.27	
-232	3.53	69.44	
-233	3.53	72.62	
-234	3.53	75.79	
-235	3.53	78.97	
-236	3.53	82.14	
-237	3.53	85.32	
-238	3.53	88.49	
-239	3.53	91.67	
-240	3.53	94.84	
-241	3.53	98.02	
-242	3.53	101.19	
-243	3.53	104.37	
-244	3.53	107.54	
-245	3.53	110.72	
-246	3.53	113.89	
-247	3.53	117.07	
-248	3.53	120.24	
-249	3.53	123.42	
-250	3.53	126.59	
-251	3.53	129.77	
-252	3.53	132.94	

Part Number	C/S	ID	Cross Ref. #
-253	3.53	136.12	
-254	3.53	139.29	
-255	3.53	142.47	
-256	3.53	145.64	
-257	3.53	148.82	
-258	3.53	151.99	
-259	3.53	158.34	
-260	3.53	164.69	
-261	3.53	171.04	
-262	3.53	177.39	
-263	3.53	183.74	
-264	3.53	190.09	
-265	3.53	196.44	
-266	3.53	202.79	
-267	3.53	209.14	
-268	3.53	215.49	
-269	3.53	221.84	
-270	3.53	228.19	
-271	3.53	234.54	
-272	3.53	240.89	
-273	3.53	247.24	
-274	3.53	253.59	
-275	3.53	266.29	
-276	3.53	278.99	
-277	3.53	291.69	
-278	3.53	304.39	
-279	3.53	329.79	
-280	3.53	355.19	
-281	3.53	380.59	
-282	3.53	405.26	
-283	3.53	430.68	
-284	3.53	456.06	
360183	3.60	18.30	
360198	3.60	19.80	
360213	3.60	21.30	
36023	3.60	23.00	
360246	3.60	24.60	
360262	3.60	26.20	
360278	3.60	27.80	
360293	3.60	29.30	
360308	3.60	30.80	
360325	3.60	32.50	
360341	3.60	34.10	
360356	3.60	35.60	
360373	3.60	37.30	
360434	3.60	43.40	

Part Number	C/S	ID	Cross Ref. #
40004	4.00	4.00	
40005	4.00	5.00	
40006	4.00	6.00	
40007	4.00	7.00	
40008	4.00	8.00	
40009	4.00	9.00	
40010	4.00	10.00	
40011	4.00	11.00	
40012	4.00	12.00	
40013	4.00	13.00	
40014	4.00	14.00	
400145	4.00	14.50	V15
40015	4.00	15.00	
40016	4.00	16.00	
40017	4.00	17.00	
40018	4.00	18.00	
40019	4.00	19.00	
40020	4.00	20.00	
40021	4.00	21.00	
40022	4.00	22.00	
40023	4.00	23.00	
400235	4.00	23.50	V24
40024	4.00	24.00	
40025	4.00	25.00	
40026	4.00	26.00	
40027	4.00	27.00	
40028	4.00	28.00	
40029	4.00	29.00	
40030	4.00	30.00	
40031	4.00	31.00	
40032	4.00	32.00	
40033	4.00	33.00	
400335	4.00	33.50	V34
40034	4.00	34.00	
40035	4.00	35.00	
400355	4.00	35.50	V36
40036	4.00	36.00	
40037	4.00	37.00	
40038	4.00	38.00	
40039	4.00	39.00	
400395	4.00	39.50	V40
40040	4.00	40.00	
40041	4.00	41.00	
40042	4.00	42.00	
40043	4.00	43.00	
40044	4.00	44.00	
40045	4.00	45.00	

Part Number	C/S	ID	Cross Ref. #
40046	4.00	46.00	
40047	4.00	47.00	
40048	4.00	48.00	
40049	4.00	49.00	
40050	4.00	50.00	
40051	4.00	51.00	
40052	4.00	52.00	
40053	4.00	53.00	
40054	4.00	54.00	
400545	4.00	54.50	V55
40055	4.00	55.00	
40056	4.00	56.00	
40057	4.00	57.00	
40058	4.00	58.00	
40059	4.00	59.00	
40060	4.00	60.00	
40061	4.00	61.00	
40062	4.00	62.00	
40063	4.00	63.00	
40064	4.00	64.00	
40065	4.00	65.00	
40066	4.00	66.00	
40067	4.00	67.00	
40068	4.00	68.00	
40069	4.00	69.00	V70
40070	4.00	70.00	
40071	4.00	71.00	
40072	4.00	72.00	
40073	4.00	73.00	
40074	4.00	74.00	
40075	4.00	75.00	
40076	4.00	76.00	
40077	4.00	77.00	
40078	4.00	78.00	
40079	4.00	79.00	
40080	4.00	80.00	
40081	4.00	81.00	
40082	4.00	82.00	
40083	4.00	83.00	
40084	4.00	84.00	V85
40085	4.00	85.00	
40086	4.00	86.00	
40087	4.00	87.00	
40088	4.00	88.00	
40089	4.00	89.00	
40090	4.00	90.00	
40091	4.00	91.00	

Part Number	C/S	ID	Cross Ref. #
40092	4.00	92.00	
40093	4.00	93.00	
40094	4.00	94.00	
40109	4.00	109.00	
40110	4.00	110.00	
40111	4.00	111.00	
40112	4.00	112.00	
40113	4.00	113.00	
40114	4.00	114.00	
40115	4.00	115.00	
40116	4.00	116.00	
40117	4.00	117.00	
40118	4.00	118.00	
40119	4.00	119.00	V120
40120	4.00	120.00	
40121	4.00	121.00	
40122	4.00	122.00	
40123	4.00	123.00	
40124	4.00	124.00	
40125	4.00	125.00	
40126	4.00	126.00	
40127	4.00	127.00	
40128	4.00	128.00	
40129	4.00	129.00	
40130	4.00	130.00	
40131	4.00	131.00	
40132	4.00	132.00	
40133	4.00	133.00	
40134	4.00	134.00	
40135	4.00	135.00	
40136	4.00	136.00	
40137	4.00	137.00	
40138	4.00	138.00	
40139	4.00	139.00	
40140	4.00	140.00	
40141	4.00	141.00	
40142	4.00	142.00	
40143	4.00	143.00	
40144	4.00	144.00	
40145	4.00	145.00	
40146	4.00	146.00	
40147	4.00	147.00	
40148	4.00	148.00	
401485	4.00	148.50	V150
40149	4.00	149.00	
40150	4.00	150.00	
40151	4.00	151.00	

Part Number	C/S	ID	Cross Ref. #
40152	4.00	152.00	
40153	4.00	153.00	
40154	4.00	154.00	
40155	4.00	155.00	
40156	4.00	156.00	
40157	4.00	157.00	
40158	4.00	158.00	
40159	4.00	159.00	
40160	4.00	160.00	
40161	4.00	161.00	
40162	4.00	162.00	
40163	4.00	163.00	
40164	4.00	164.00	
40165	4.00	165.00	
40166	4.00	166.00	
40167	4.00	167.00	
40168	4.00	168.00	
40169	4.00	169.00	
40170	4.00	170.00	
40171	4.00	171.00	
40172	4.00	172.00	
40173	4.00	173.00	V175
40174	4.00	174.00	
40175	4.00	175.00	
40176	4.00	176.00	
40177	4.00	177.00	
40178	4.00	178.00	
40179	4.00	179.00	
40180	4.00	180.00	
40181	4.00	181.00	
40182	4.00	182.00	
40183	4.00	183.00	
40184	4.00	184.00	
40185	4.00	185.00	
40186	4.00	186.00	
40187	4.00	187.00	
40188	4.00	188.00	
40189	4.00	189.00	
40190	4.00	190.00	
40191	4.00	191.00	
40192	4.00	192.00	
40193	4.00	193.00	
40194	4.00	194.00	
40195	4.00	195.00	
40196	4.00	196.00	
40197	4.00	197.00	

Part Number	C/S	ID	Cross Ref. #
40198	4.00	198.00	
40199	4.00	199.00	
40200	4.00	200.00	
40201	4.00	201.00	
40202	4.00	202.00	
40203	4.00	203.00	
40204	4.00	204.00	
40205	4.00	205.00	
40206	4.00	206.00	
40207	4.00	207.00	
40208	4.00	208.00	
40209	4.00	209.00	
40210	4.00	210.00	
45006	4.50	6.00	
45008	4.50	8.00	
45009	4.50	9.00	
45010	4.50	10.00	
45011	4.50	11.00	
45012	4.50	12.00	
45013	4.50	13.00	
45015	4.50	15.00	
45016	4.50	16.00	
45017	4.50	17.00	
45018	4.50	18.00	
45019	4.50	19.00	
45020	4.50	20.00	
45021	4.50	21.00	
45022	4.50	22.00	
45023	4.50	23.00	
45024	4.50	24.00	
45025	4.50	25.00	
45026	4.50	26.00	
45028	4.50	28.00	
45029	4.50	29.00	
45030	4.50	30.00	
45031	4.50	31.00	
45032	4.50	32.00	
45033	4.50	33.00	
45034	4.50	34.00	
45035	4.50	35.00	
45036	4.50	36.00	
45037	4.50	37.00	
45038	4.50	38.00	
45039	4.50	39.00	
45040	4.50	40.00	
45041	4.50	41.00	

Part Number	C/S	ID	Cross Ref. #
45042	4.50	42.00	
45043	4.50	43.00	
45044	4.50	44.00	
45045	4.50	45.00	
45046	4.50	46.00	
45047	4.50	47.00	
45048	4.50	48.00	
45049	4.50	49.00	
45050	4.50	50.00	
45051	4.50	51.00	
45053	4.50	53.00	
45056	4.50	56.00	
45057	4.50	57.00	
45060	4.50	60.00	
45061	4.50	61.00	
45062	4.50	62.00	
45063	4.50	63.00	
45064	4.50	64.00	
45065	4.50	65.00	
45066	4.50	66.00	
45068	4.50	68.00	
45069	4.50	69.00	
45070	4.50	70.00	
45071	4.50	71.00	
45073	4.50	73.00	
45074	4.50	74.00	
45075	4.50	75.00	
45076	4.50	76.00	
45080	4.50	80.00	
45081	4.50	81.00	
45083	4.50	83.00	
45085	4.50	85.00	
45086	4.50	86.00	
45089	4.50	89.00	
45090	4.50	90.00	
45092	4.50	92.00	
45095	4.50	95.00	
45098	4.50	98.00	
45100	4.50	100.00	
45101	4.50	101.00	
45105	4.50	105.00	
45106	4.50	106.00	
45110	4.50	110.00	
45115	4.50	115.00	
45118	4.50	118.00	
45120	4.50	120.00	

Part Number	C/S	ID	Cross Ref. #
45122	4.50	122.00	
45124	4.50	124.00	
45126	4.50	126.00	
45128	4.50	128.00	
45130	4.50	130.00	
45137	4.50	137.00	
45140	4.50	140.00	
45150	4.50	150.00	
45153	4.50	153.00	
45155	4.50	155.00	
45157	4.50	157.00	
45160	4.50	160.00	
45165	4.50	165.00	
50004	5.00	4.00	
50005	5.00	5.00	
50006	5.00	6.00	
50007	5.00	7.00	
50008	5.00	8.00	
50009	5.00	9.00	
50010	5.00	10.00	
50011	5.00	11.00	
50012	5.00	12.00	
50013	5.00	13.00	
50014	5.00	14.00	
50015	5.00	15.00	
50016	5.00	16.00	
50017	5.00	17.00	
50018	5.00	18.00	
50019	5.00	19.00	
50020	5.00	20.00	
50021	5.00	21.00	
50022	5.00	22.00	
50023	5.00	23.00	
50024	5.00	24.00	
50025	5.00	25.00	
50026	5.00	26.00	
50027	5.00	27.00	
50028	5.00	28.00	
50029	5.00	29.00	
50030	5.00	30.00	
50031	5.00	31.00	
50032	5.00	32.00	
50033	5.00	33.00	
50034	5.00	34.00	
50035	5.00	35.00	
50036	5.00	36.00	

Part Number	C/S	ID	Cross Ref. #
50037	5.00	37.00	
50038	5.00	38.00	
50039	5.00	39.00	
50040	5.00	40.00	
50041	5.00	41.00	
50042	5.00	42.00	
50043	5.00	43.00	
50044	5.00	44.00	
50045	5.00	45.00	
50046	5.00	46.00	
50047	5.00	47.00	
50048	5.00	48.00	
50049	5.00	49.00	
50050	5.00	50.00	
50051	5.00	51.00	
50052	5.00	52.00	
50053	5.00	53.00	
50054	5.00	54.00	
50055	5.00	55.00	
50056	5.00	56.00	
50057	5.00	57.00	
50058	5.00	58.00	
50059	5.00	59.00	
50060	5.00	60.00	
50061	5.00	61.00	
50062	5.00	62.00	
50063	5.00	63.00	
50064	5.00	64.00	
50065	5.00	65.00	
50066	5.00	66.00	
50067	5.00	67.00	
50068	5.00	68.00	
50069	5.00	69.00	
50070	5.00	70.00	
50071	5.00	71.00	
50072	5.00	72.00	
50073	5.00	73.00	
50074	5.00	74.00	
50075	5.00	75.00	
50076	5.00	76.00	
50077	5.00	77.00	
50078	5.00	78.00	
50079	5.00	79.00	
50080	5.00	80.00	
50081	5.00	81.00	
50082	5.00	82.00	

Part Number	C/S	ID	Cross Ref. #
50083	5.00	83.00	
50084	5.00	84.00	
50085	5.00	85.00	
50086	5.00	86.00	
50087	5.00	87.00	
50088	5.00	88.00	
50089	5.00	89.00	
50090	5.00	90.00	
50091	5.00	91.00	
50092	5.00	92.00	
50093	5.00	93.00	
50094	5.00	94.00	
50095	5.00	95.00	
50096	5.00	96.00	
50097	5.00	97.00	
50098	5.00	98.00	
50099	5.00	99.00	
50100	5.00	100.00	
50101	5.00	101.00	
50102	5.00	102.00	
50103	5.00	103.00	
50104	5.00	104.00	
50105	5.00	105.00	
50106	5.00	106.00	
50107	5.00	107.00	
50108	5.00	108.00	
50109	5.00	109.00	
50110	5.00	110.00	
50111	5.00	111.00	
50112	5.00	112.00	
50113	5.00	113.00	
50114	5.00	114.00	
50115	5.00	115.00	
50116	5.00	116.00	
50117	5.00	117.00	
50118	5.00	118.00	
50119	5.00	119.00	
50120	5.00	120.00	
50121	5.00	121.00	
50122	5.00	122.00	
50123	5.00	123.00	
50124	5.00	124.00	
50125	5.00	125.00	
50126	5.00	126.00	
50127	5.00	127.00	
50128	5.00	128.00	

Part Number	C/S	ID	Cross Ref. #
50129	5.00	129.00	
50130	5.00	130.00	
50131	5.00	131.00	
50132	5.00	132.00	
50133	5.00	133.00	
50134	5.00	134.00	
50135	5.00	135.00	
50136	5.00	136.00	
50137	5.00	137.00	
50138	5.00	138.00	
50139	5.00	139.00	
50140	5.00	140.00	
50141	5.00	141.00	
50142	5.00	142.00	
50143	5.00	143.00	
50144	5.00	144.00	
50145	5.00	145.00	
50146	5.00	146.00	
50147	5.00	147.00	
50148	5.00	148.00	
50149	5.00	149.00	
50150	5.00	150.00	
50151	5.00	151.00	
50152	5.00	152.00	
50153	5.00	153.00	
50154	5.00	154.00	
50155	5.00	155.00	
50156	5.00	156.00	
50157	5.00	157.00	
50158	5.00	158.00	
50159	5.00	159.00	
50160	5.00	160.00	
50161	5.00	161.00	
50162	5.00	162.00	
50163	5.00	163.00	
50164	5.00	164.00	
50165	5.00	165.00	
50166	5.00	166.00	
50167	5.00	167.00	
50168	5.00	168.00	
50169	5.00	169.00	
50170	5.00	170.00	
50171	5.00	171.00	
50172	5.00	172.00	
50173	5.00	173.00	
50174	5.00	174.00	

Part Number	C/S	ID	Cross Ref. #
50175	5.00	175.00	
50176	5.00	176.00	
50177	5.00	177.00	
50178	5.00	178.00	
50179	5.00	179.00	
50180	5.00	180.00	
50181	5.00	181.00	
50182	5.00	182.00	
50183	5.00	183.00	
50184	5.00	184.00	
50185	5.00	185.00	
50186	5.00	186.00	
50187	5.00	187.00	
50188	5.00	188.00	
50189	5.00	189.00	
50190	5.00	190.00	
50191	5.00	191.00	
50192	5.00	192.00	
50193	5.00	193.00	
50194	5.00	194.00	
50195	5.00	195.00	
50196	5.00	196.00	
50197	5.00	197.00	
50198	5.00	198.00	
50199	5.00	199.00	
50200	5.00	200.00	
50201	5.00	201.00	
50202	5.00	202.00	
50203	5.00	203.00	
50204	5.00	204.00	
50205	5.00	205.00	
50206	5.00	206.00	
50207	5.00	207.00	
50208	5.00	208.00	
50209	5.00	209.00	
50210	5.00	210.00	
50211	5.00	211.00	
50212	5.00	212.00	
50213	5.00	213.00	
50214	5.00	214.00	
50215	5.00	215.00	
50216	5.00	216.00	
50217	5.00	217.00	
50218	5.00	218.00	
50219	5.00	219.00	
50220	5.00	220.00	

Part Number	C/S	ID	Cross Ref. #
50221	5.00	221.00	
50222	5.00	222.00	
50223	5.00	223.00	
50224	5.00	224.00	
50225	5.00	225.00	
50226	5.00	226.00	
50227	5.00	227.00	
50228	5.00	228.00	
50229	5.00	229.00	
50230	5.00	230.00	
50231	5.00	231.00	
50232	5.00	232.00	
50233	5.00	233.00	
50234	5.00	234.00	
50235	5.00	235.00	
50236	5.00	236.00	
50237	5.00	237.00	
50238	5.00	238.00	
50239	5.00	239.00	
50240	5.00	240.00	
50241	5.00	241.00	
50242	5.00	242.00	
50243	5.00	243.00	
50244	5.00	244.00	
50245	5.00	245.00	
50246	5.00	246.00	
50247	5.00	247.00	
50248	5.00	248.00	
50249	5.00	249.00	
50250	5.00	250.00	
53040	5.30	40.00	
530412	5.30	41.20	
530414	5.30	41.40	
530425	5.30	42.50	
530437	5.30	43.70	
53045	5.30	45.00	
530462	5.30	46.20	
530475	5.30	47.50	
530487	5.30	48.70	
53050	5.30	50.00	
530515	5.30	51.50	
53053	5.30	53.00	
530544	5.30	54.40	
530545	5.30	54.50	
53056	5.30	56.00	
53058	5.30	58.00	

Part Number	C/S	ID	Cross Ref. #
53060	5.30	60.00	
530615	5.30	61.50	
53063	5.30	63.00	
53065	5.30	65.00	
53067	5.30	67.00	
53069	5.30	69.00	
53071	5.30	71.00	
53073	5.30	73.00	
53075	5.30	75.00	
530775	5.30	77.50	
53080	5.30	80.00	
530825	5.30	82.50	
53085	5.30	85.00	
530875	5.30	87.50	
53090	5.30	90.00	
530925	5.30	92.50	
53095	5.30	95.00	
530975	5.30	97.50	
53100	5.30	100.00	
53103	5.30	103.00	
53106	5.30	106.00	
53109	5.30	109.00	
53112	5.30	112.00	
53115	5.30	115.00	
53118	5.30	118.00	
53122	5.30	122.00	
53125	5.30	125.00	
53128	5.30	128.00	
53132	5.30	132.00	
53136	5.30	136.00	
53140	5.30	140.00	
53145	5.30	145.00	
53150	5.30	150.00	
53155	5.30	155.00	
53160	5.30	160.00	
53165	5.30	165.00	
53170	5.30	170.00	
53175	5.30	175.00	
53180	5.30	180.00	
53185	5.30	185.00	
53190	5.30	190.00	
53195	5.30	195.00	
53200	5.30	200.00	
-309	5.33	10.46	
-310	5.33	12.07	
-311	5.33	13.64	

Part Number	C/S	ID	Cross Ref. #
-312	5.33	15.24	
-313	5.33	16.81	
-314	5.33	18.42	
-315	5.33	19.99	
-316	5.33	21.59	
-317	5.33	23.16	
-318	5.33	24.77	
-319	5.33	26.34	
-320	5.33	27.94	
-321	5.33	29.51	
-322	5.33	31.12	
-323	5.33	32.69	
-324	5.33	34.29	
-325	5.33	37.47	
-326	5.33	40.64	
-327	5.33	43.82	
-328	5.33	46.99	
-329	5.33	50.17	
-330	5.33	53.34	
-331	5.33	56.52	
-332	5.33	59.69	
-333	5.33	62.87	
-334	5.33	66.04	
-335	5.33	69.22	
-336	5.33	72.39	
-337	5.33	75.57	
-338	5.33	78.74	
-339	5.33	81.92	
-340	5.33	85.09	
-341	5.33	88.27	
-342	5.33	91.44	
-343	5.33	94.62	
-344	5.33	97.79	
-345	5.33	100.97	
-346	5.33	104.14	
-347	5.33	107.32	
-348	5.33	110.49	
-349	5.33	113.67	
-350	5.33	116.84	
-351	5.33	120.02	
-352	5.33	123.19	
-353	5.33	126.37	
-354	5.33	129.54	
-355	5.33	132.72	
-356	5.33	135.89	
-357	5.33	139.07	

Part Number	C/S	ID	Cross Ref. #
-358	5.33	142.24	
-359	5.33	145.42	
-360	5.33	148.59	
-361	5.33	151.77	
-362	5.33	158.12	
-363	5.33	164.47	
-364	5.33	170.82	
-365	5.33	177.17	
-366	5.33	183.52	
-367	5.33	189.87	
-368	5.33	196.22	
-369	5.33	202.57	
-370	5.33	208.92	
-371	5.33	215.27	
-372	5.33	221.62	
-373	5.33	227.97	
-374	5.33	234.32	
-375	5.33	240.67	
-376	5.33	247.02	
-377	5.33	253.37	
-378	5.33	266.07	
-379	5.33	278.77	
-380	5.33	291.47	
-381	5.33	304.17	
-382	5.33	329.57	
-383	5.33	354.97	
-384	5.33	380.37	
-385	5.33	405.26	
-386	5.33	430.66	
-387	5.33	456.06	
-388	5.33	481.38	
-389	5.33	506.78	
-390	5.33	532.18	
-391	5.33	557.58	
-392	5.33	582.68	
-393	5.33	608.08	
-394	5.33	633.48	
-395	5.33	658.88	
570242	5.70	24.20	
570352	5.70	35.20	
570362	5.70	36.20	
570372	5.70	37.20	
570392	5.70	39.20	
570412	5.70	41.20	
570442	5.70	44.20	
570443	5.70	44.30	

Part Number	C/S	ID	Cross Ref. #
570452	5.70	45.20	
570453	5.70	45.30	
570472	5.70	47.20	
570476	5.70	47.60	P48A
570492	5.70	49.20	
570493	5.70	49.30	
570496	5.70	49.60	P50A
570512	5.70	51.20	
570516	5.70	51.60	P52
570522	5.70	52.20	
570523	5.70	52.30	
570525	5.70	52.50	
570526	5.70	52.60	P53
570530	5.70	53.00	
570542	5.70	54.20	
570543	5.70	54.30	
570546	5.70	54.60	P55
570552	5.70	55.20	
570553	5.70	55.30	
570556	5.70	55.60	P56
570572	5.70	57.20	
570576	5.70	57.60	P58
570592	5.70	59.20	
570593	5.70	59.30	
570596	5.70	59.60	P60
570597	5.70	59.70	
570612	5.70	61.20	
570616	5.70	61.60	P62
57062	5.70	62.00	
570622	5.70	62.20	
570623	5.70	62.30	
570626	5.70	62.60	P63
57064	5.70	64.00	
570642	5.70	64.20	
570643	5.70	64.30	
570646	5.70	64.60	P65
570666	5.70	66.60	P67
570672	5.70	67.20	
57069	5.70	69.00	
570692	5.70	69.20	
570693	5.70	69.30	
570696	5.70	69.60	P70
570702	5.70	70.20	
570706	5.70	70.60	P71
570712	5.70	71.20	
570722	5.70	72.20	
570723	5.70	72.30	

Part Number	C/S	ID	Cross Ref. #
57074	5.70	74.00	
570742	5.70	74.20	
570743	5.70	74.30	
570746	5.70	74.60	P75
570772	5.70	77.20	
57079	5.70	79.00	
570792	5.70	79.20	
570793	5.70	79.30	
570796	5.70	79.60	P80
570812	5.70	81.20	
570822	5.70	82.20	
570842	5.70	84.20	
570846	5.70	84.60	P85
570872	5.70	87.20	
570891	5.70	89.10	
570892	5.70	89.20	
570893	5.70	89.30	
570896	5.70	89.60	P90
570922	5.70	92.20	
570942	5.70	94.20	
570946	5.70	94.60	P95
570966	5.70	96.60	
570992	5.70	99.20	
570996	5.70	99.60	P100
571016	5.70	101.60	P102
571046	5.70	104.60	P105
571092	5.70	109.20	
571093	5.70	109.30	
571096	5.70	109.60	P110
571116	5.70	111.60	P112
571142	5.70	114.20	
571143	5.70	114.30	
571146	5.70	114.60	P115
571192	5.70	119.20	
571196	5.70	119.60	P120
571246	5.70	124.60	P125
571292	5.70	129.20	
571296	5.70	129.60	P130
571316	5.70	131.60	P132
571342	5.70	134.20	
571346	5.70	134.60	P135
571392	5.70	139.20	
571393	5.70	139.30	
571396	5.70	139.60	P140
571442	5.70	144.20	
571446	5.70	144.60	P145
571492	5.70	149.20	

Part Number	C/S	ID	Cross Ref. #
571493	5.70	149.30	G150
571496	5.70	149.60	P150
571543	5.70	154.30	G155
571593	5.70	159.30	G160
571642	5.70	164.20	
571643	5.70	164.30	G165
571693	5.70	169.30	G170
571742	5.70	174.20	
571743	5.70	174.30	G175
571793	5.70	179.30	G180
571843	5.70	184.30	G185
571892	5.70	189.20	
571893	5.70	189.30	G190
571942	5.70	194.20	
571943	5.70	194.30	G195
571992	5.70	199.20	
571993	5.70	199.30	G200
572042	5.70	204.20	
572092	5.70	209.20	
572093	5.70	209.30	G210
572193	5.70	219.30	G220
572293	5.70	229.30	G230
572343	5.70	234.30	
572393	5.70	239.30	G240
572493	5.70	249.30	G250
572593	5.70	259.30	G260
572693	5.70	269.30	G270
572793	5.70	279.30	G280
572893	5.70	289.30	G290
572993	5.70	299.30	G300
573193	5.70	319.30	
573393	5.70	339.30	
573493	5.70	349.30	
573593	5.70	359.30	
573793	5.70	379.30	
573993	5.70	399.30	
60012	6.00	12.00	
60018	6.00	18.00	
60020	6.00	20.00	
60023	6.00	23.00	
60024	6.00	24.00	
60025	6.00	25.00	
60026	6.00	26.00	
60032	6.00	32.00	
60034	6.00	34.00	
60035	6.00	35.00	
60036	6.00	36.00	

Part Number	C/S	ID	Cross Ref. #
60037	6.00	37.00	
60038	6.00	38.00	
60040	6.00	40.00	
60041	6.00	41.00	
60042	6.00	42.00	
60044	6.00	44.00	
60045	6.00	45.00	
60046	6.00	46.00	
60048	6.00	48.00	
60050	6.00	50.00	
60052	6.00	52.00	
60056	6.00	56.00	
60058	6.00	58.00	
60059	6.00	59.00	
60060	6.00	60.00	
60062	6.00	62.00	
60064	6.00	64.00	
60065	6.00	65.00	
60067	6.00	67.00	
60069	6.00	69.00	
60070	6.00	70.00	
60072	6.00	72.00	
60073	6.00	73.00	
60074	6.00	74.00	
60075	6.00	75.00	
60076	6.00	76.00	
60079	6.00	79.00	
60080	6.00	80.00	
60085	6.00	85.00	
60086	6.00	86.00	
60088	6.00	88.00	
60090	6.00	90.00	
60092	6.00	92.00	
60095	6.00	95.00	
60098	6.00	98.00	
60100	6.00	100.00	
60103	6.00	103.00	
60105	6.00	105.00	
60110	6.00	110.00	
60112	6.00	112.00	
60114	6.00	114.00	
60115	6.00	115.00	
60118	6.00	118.00	
60120	6.00	120.00	
60122	6.00	122.00	
60125	6.00	125.00	
60128	6.00	128.00	

Part Number	C/S	ID	Cross Ref. #
60130	6.00	130.00	
60134	6.00	134.00	
60135	6.00	135.00	
60138	6.00	138.00	
60140	6.00	140.00	
60142	6.00	142.00	
60145	6.00	145.00	
60146	6.00	146.00	
60148	6.00	148.00	
60150	6.00	150.00	
60160	6.00	160.00	
60165	6.00	165.00	
60166	6.00	166.00	
60169	6.00	169.00	
60170	6.00	170.00	
60172	6.00	172.00	
60175	6.00	175.00	
60180	6.00	180.00	
60185	6.00	185.00	
60190	6.00	190.00	
60195	6.00	195.00	
60200	6.00	200.00	
60208	6.00	208.00	
60210	6.00	210.00	
60215	6.00	215.00	
60220	6.00	220.00	
602225	6.00	222.50	V225
60230	6.00	230.00	
60242	6.00	242.00	
60250	6.00	250.00	
60262	6.00	262.00	
60266	6.00	266.00	
60270	6.00	270.00	
60272	6.00	272.00	V275
60290	6.00	290.00	
60295	6.00	295.00	
60300	6.00	300.00	
60320	6.00	320.00	
603215	6.00	321.50	V325
60330	6.00	330.00	
60355	6.00	355.00	
60365	6.00	365.00	
60370	6.00	370.00	
60376	6.00	376.00	
603765	6.00	376.50	V380
60380	6.00	380.00	
60385	6.00	385.00	

Part Number	C/S	ID	Cross Ref. #
60392	6.00	392.00	
60394	6.00	394.00	
604255	6.00	425.50	V430
60429	6.00	429.00	
60445	6.00	445.00	
60478	6.00	478.00	
60480	6.00	480.00	
60500	6.00	500.00	
60504	6.00	504.00	
60525	6.00	525.00	
60575	6.00	575.00	
-425	6.99	113.67	
-426	6.99	116.84	
-427	6.99	120.02	
-428	6.99	123.19	
-429	6.99	126.37	
-430	6.99	129.54	
-431	6.99	132.72	
-432	6.99	135.89	
-433	6.99	139.07	
-434	6.99	142.24	
-435	6.99	145.42	
-436	6.99	148.59	
-437	6.99	151.77	
-438	6.99	158.12	
-439	6.99	164.47	
-440	6.99	170.82	
-441	6.99	177.17	
-442	6.99	183.52	
-443	6.99	189.87	
-444	6.99	196.22	
-445	6.99	202.57	
-446	6.99	215.27	
-447	6.99	227.97	
-448	6.99	240.67	
-449	6.99	253.37	
-450	6.99	266.07	
-451	6.99	278.77	
-452	6.99	291.47	
-453	6.99	304.17	
-454	6.99	316.87	
-455	6.99	329.57	
-456	6.99	342.27	
-457	6.99	354.97	
-458	6.99	367.67	
-459	6.99	380.37	
-460	6.99	393.07	

Part Number	C/S	ID	Cross Ref. #
-461	6.99	405.26	
-462	6.99	417.96	
-463	6.99	430.66	
-464	6.99	443.36	
-465	6.99	456.06	
-466	6.99	468.76	
-467	6.99	481.46	
-468	6.99	494.16	
-469	6.99	506.86	
-470	6.99	532.26	
-471	6.99	557.66	
-472	6.99	582.68	
-473	6.99	608.08	
-474	6.99	633.48	
-475	6.99	658.88	
70011	7.00	11.00	
70015	7.00	15.00	
70023	7.00	23.00	
70034	7.00	34.00	
70035	7.00	35.00	
70040	7.00	40.00	
70058	7.00	58.00	
70059	7.00	59.00	
70060	7.00	60.00	
70068	7.00	68.00	
70079	7.00	79.00	
70083	7.00	83.00	
70094	7.00	94.00	
70096	7.00	96.00	
70106	7.00	106.00	
70107	7.00	107.00	
70110	7.00	110.00	
70111	7.00	111.00	
701147	7.00	114.70	
70115	7.00	115.00	
70120	7.00	120.00	
70128	7.00	128.00	
70150	7.00	150.00	
701595	7.00	159.50	
70160	7.00	160.00	
701667	7.00	166.70	
701746	7.00	174.60	
70181	7.00	181.00	
701873	7.00	187.30	
70200	7.00	200.00	
702089	7.00	208.90	

Part Number	C/S	ID	Cross Ref. #
70212	7.00	212.00	
70215	7.00	215.00	
70217	7.00	217.00	
70220	7.00	220.00	
70230	7.00	230.00	
70234	7.00	234.00	
702343	7.00	234.30	
70235	7.00	235.00	
70236	7.00	236.00	
70240	7.00	240.00	
70247	7.00	247.00	
70250	7.00	250.00	
702597	7.00	259.70	
70266	7.00	266.00	
702851	7.00	285.10	
702978	7.00	297.80	
70300	7.00	300.00	
70310	7.00	310.00	
70325	7.00	325.00	
70329	7.00	329.00	
70338	7.00	338.00	
70348	7.00	348.00	
70388	7.00	388.00	
70400	7.00	400.00	
70416	7.00	416.00	
70430	7.00	430.00	
70431	7.00	431.00	
70437	7.00	437.00	
70448	7.00	448.00	
70515	7.00	515.00	
70540	7.00	540.00	
70558	7.00	558.00	
70625	7.00	625.00	
80016	8.00	16.00	
80025	8.00	25.00	
80033	8.00	33.00	
80050	8.00	50.00	
80054	8.00	54.00	
80055	8.00	55.00	
80060	8.00	60.00	
80065	8.00	65.00	
80067	8.00	67.00	
80070	8.00	70.00	
80075	8.00	75.00	
80090	8.00	90.00	
80092	8.00	92.00	

Part Number	C/S	ID	Cross Ref. #
80110	8.00	110.00	
80112	8.00	112.00	
80125	8.00	125.00	
80140	8.00	140.00	
80144	8.00	144.00	
80145	8.00	145.00	
80160	8.00	160.00	
80175	8.00	175.00	
80184	8.00	184.00	
80185	8.00	185.00	
80188	8.00	188.00	
80200	8.00	200.00	
80205	8.00	205.00	
80210	8.00	210.00	
80230	8.00	230.00	
80235	8.00	235.00	
80245	8.00	245.00	
80278	8.00	278.00	
80290	8.00	290.00	
80300	8.00	300.00	
80308	8.00	308.00	
80320	8.00	320.00	
80326	8.00	326.00	
80330	8.00	330.00	
80425	8.00	425.00	
80440	8.00	440.00	
80470	8.00	470.00	
80475	8.00	475.00	
80480	8.00	480.00	
80490	8.00	490.00	
80500	8.00	500.00	
80565	8.00	565.00	
841441	8.40	144.10	
841495	8.40	149.50	P150A
841541	8.40	154.10	
841545	8.40	154.50	P155
841591	8.40	159.10	
841595	8.40	159.50	P160
841641	8.40	164.10	
841645	8.40	164.50	P165
841695	8.40	169.50	P170
841741	8.40	174.10	
841745	8.40	174.50	P175
841795	8.40	179.50	P180
841845	8.40	184.50	P185
841895	8.40	189.50	P190

Part Number	C/S	ID	Cross Ref. #
841941	8.40	194.10	
841945	8.40	194.50	P195
841991	8.40	199.10	
841995	8.40	199.50	P200
842041	8.40	204.10	
842045	8.40	204.50	P205
842085	8.40	208.50	P209
842091	8.40	209.10	
842095	8.40	209.50	P210
842145	8.40	214.50	P215
842191	8.40	219.10	
842195	8.40	219.50	P220
842245	8.40	224.50	P225
842295	8.40	229.50	P230
842345	8.40	234.50	P235
842391	8.40	239.10	
842395	8.40	239.50	P240
842445	8.40	244.50	P245

Part Number	C/S	ID	Cross Ref. #
842495	8.40	249.50	P250
842545	8.40	254.50	P255
842595	8.40	259.50	P260
842645	8.40	264.50	P265
842695	8.40	269.50	P270
842745	8.40	274.50	P275
84319	8.40	319.00	
843345	8.40	334.50	
844191	8.40	419.10	
10X475	10.00	475.00	V480
10X5245	10.00	524.50	V530
10X579	10.00	579.00	V585
10X6335	10.00	633.50	V640
10X683	10.00	683.00	V690
10X7325	10.00	732.50	V740
10X782	10.00	782.00	V790
10X8365	10.00	836.50	V845
10X1044	10.00	1044.00	V1055